

ELETTROBAR

**SPARE PARTS CATALOGUE
ERSATZTEILKATALOG
CATALOGUE PIECES DETACHEES
CATALOGO PARTI RICAMBIO
CATALOGO DE PIEZAS DE RECAMBIO
CATALOGO PEÇAS DE REPOSIÇÃO**

E.50-51

02-11-2005

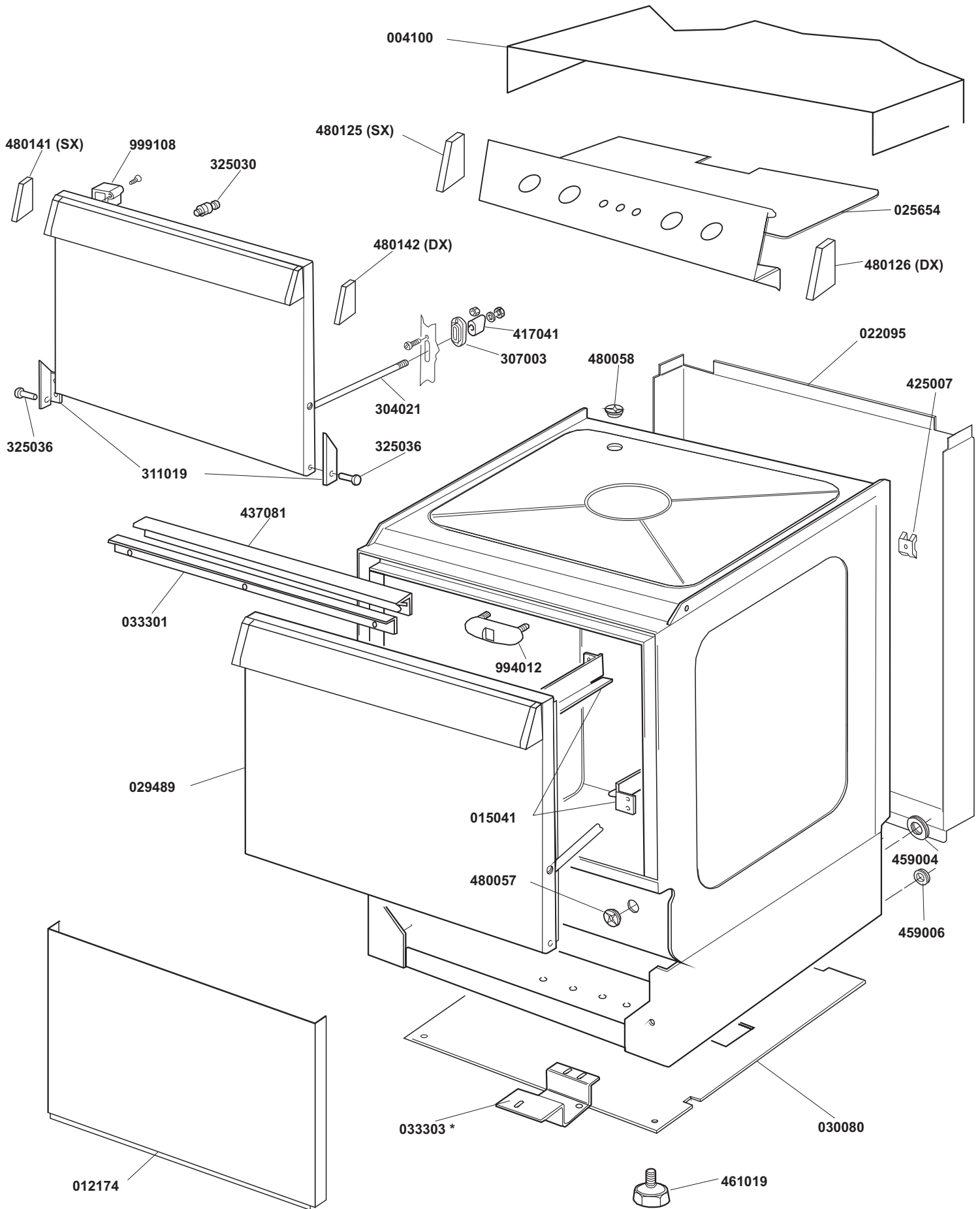

*Optional

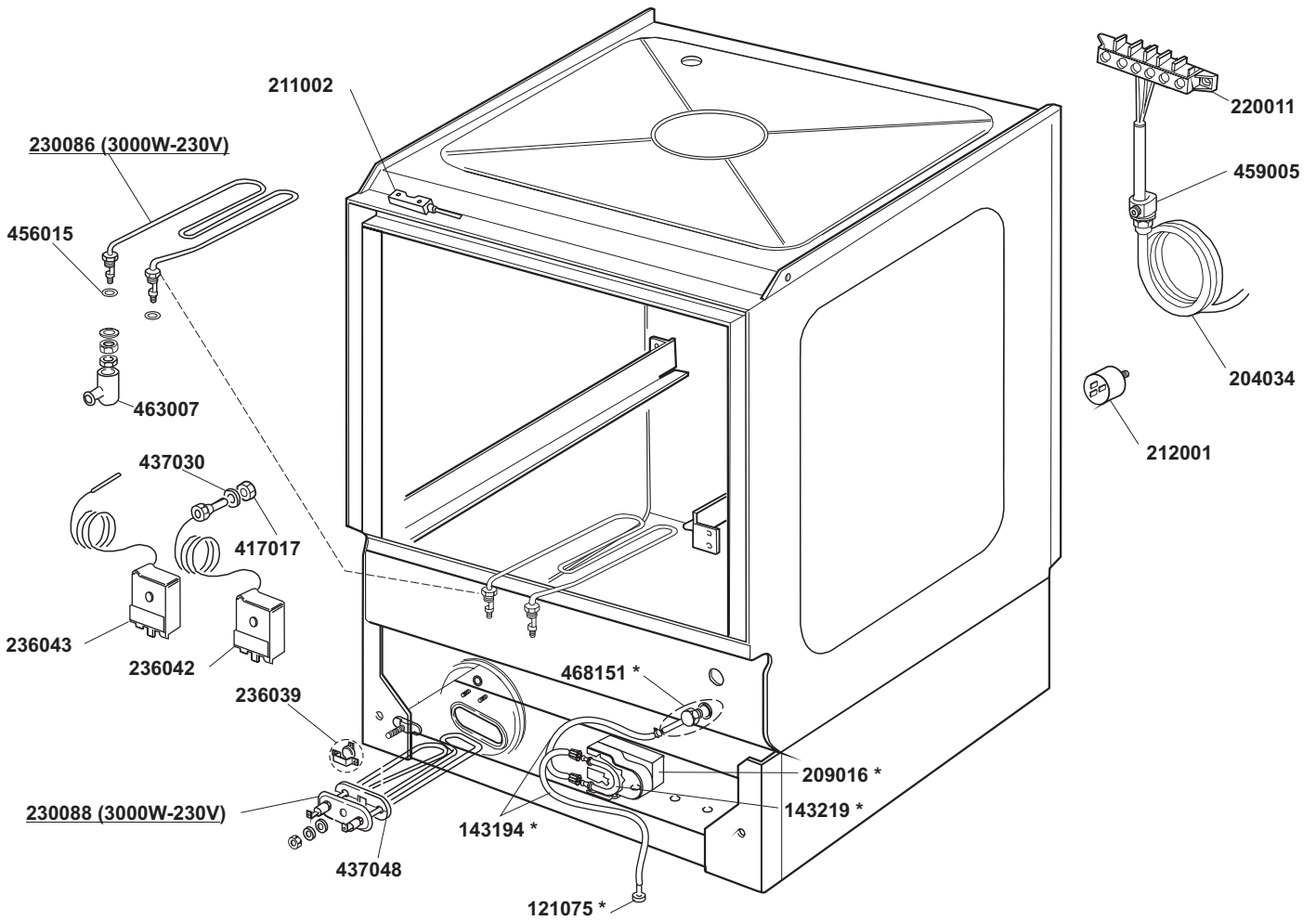
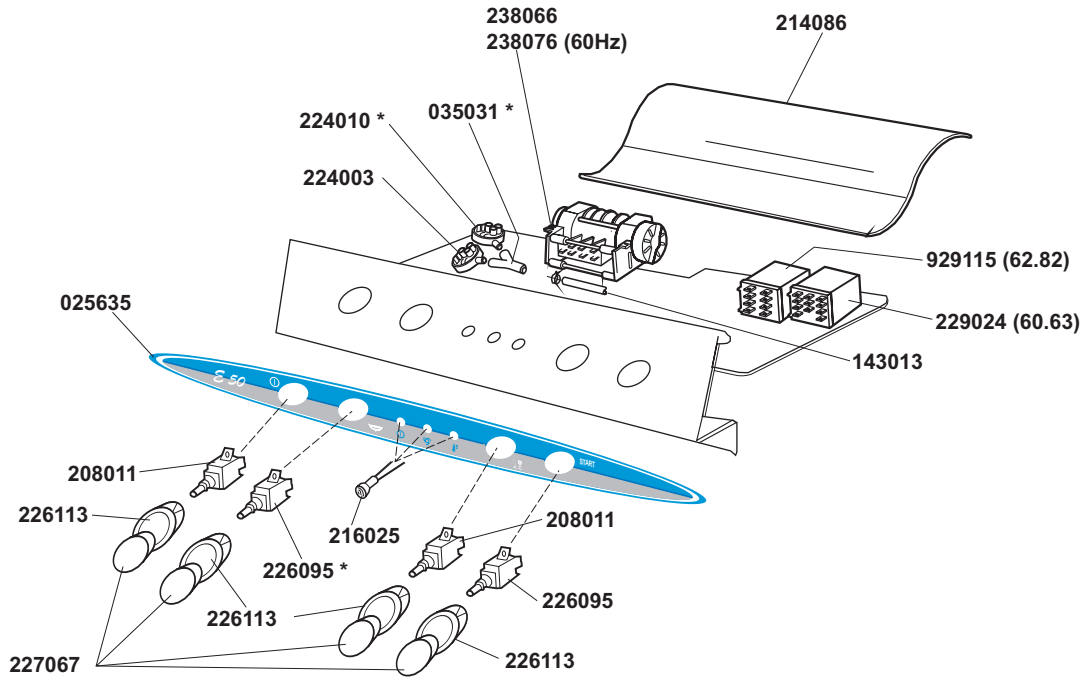

*Optional

2a

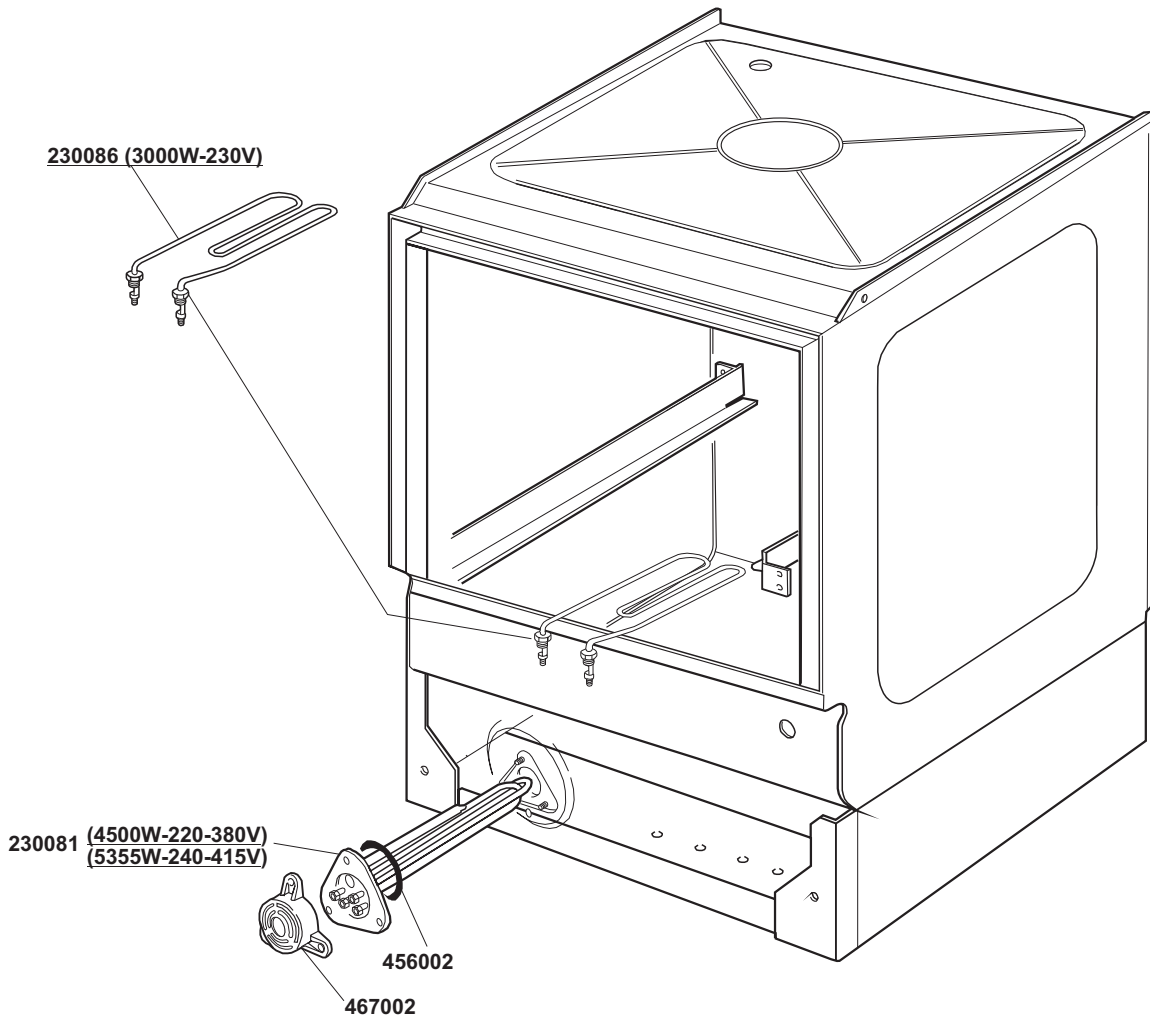
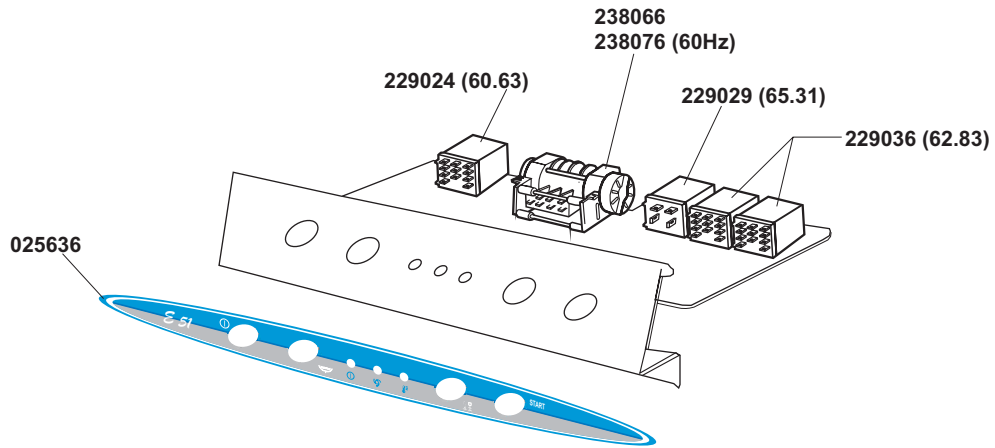

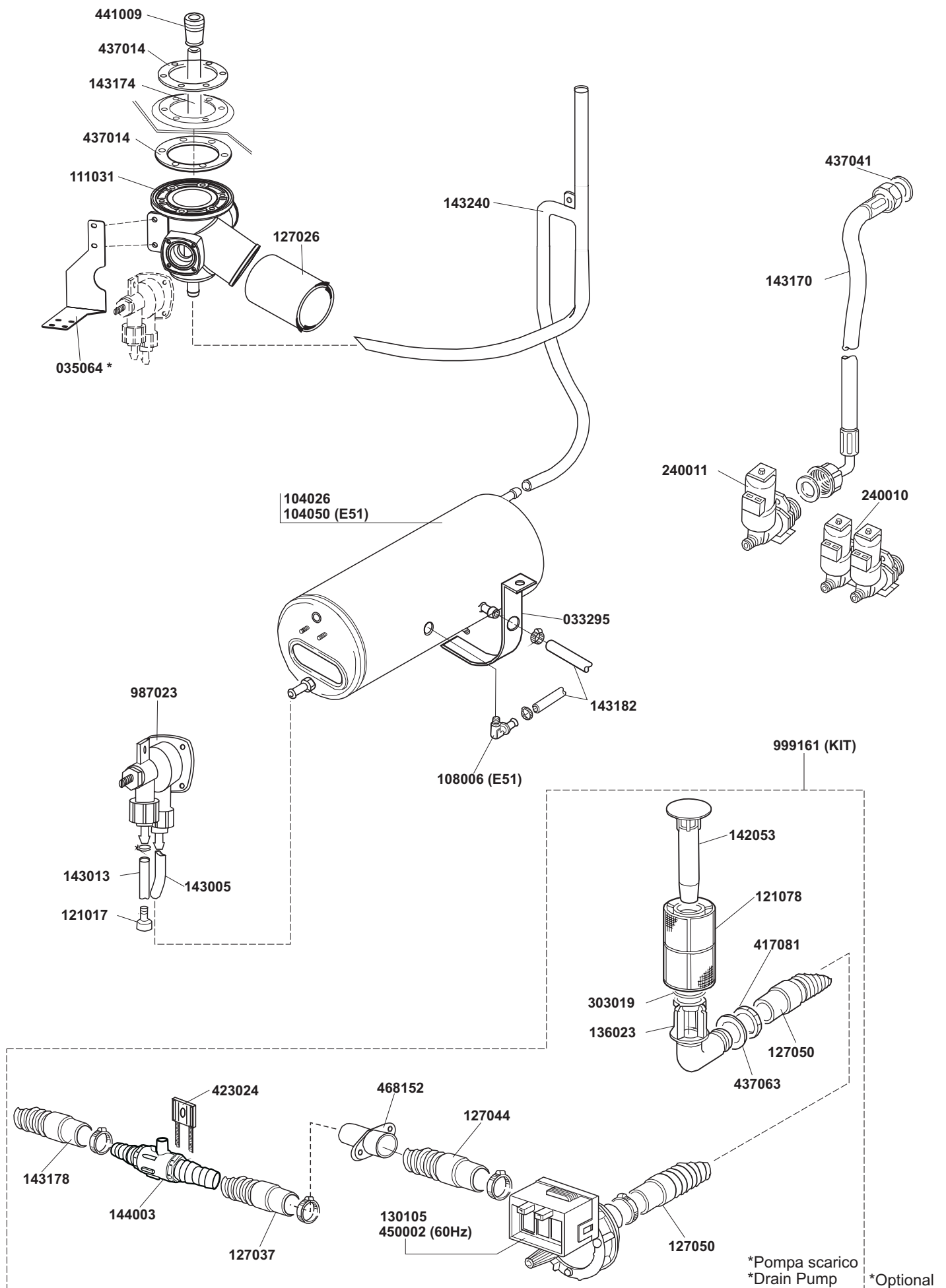

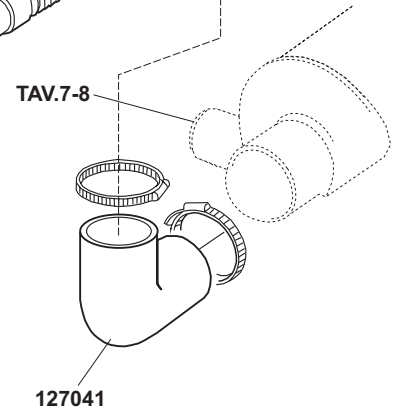
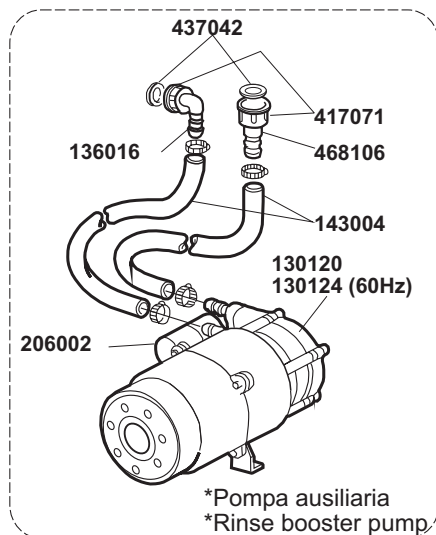
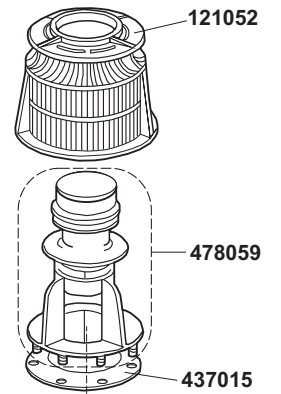
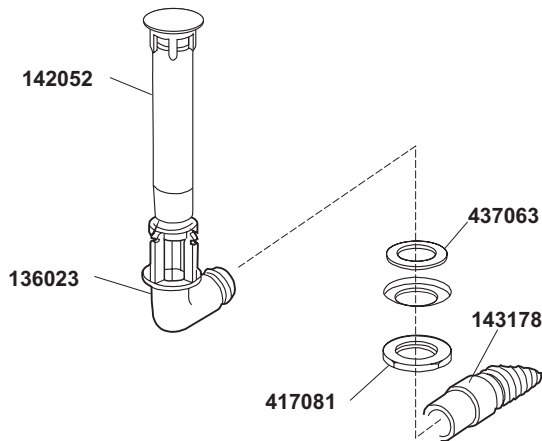
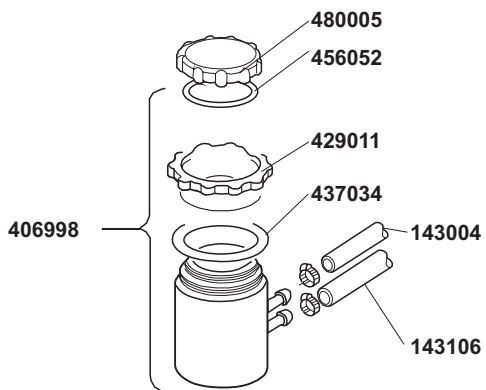
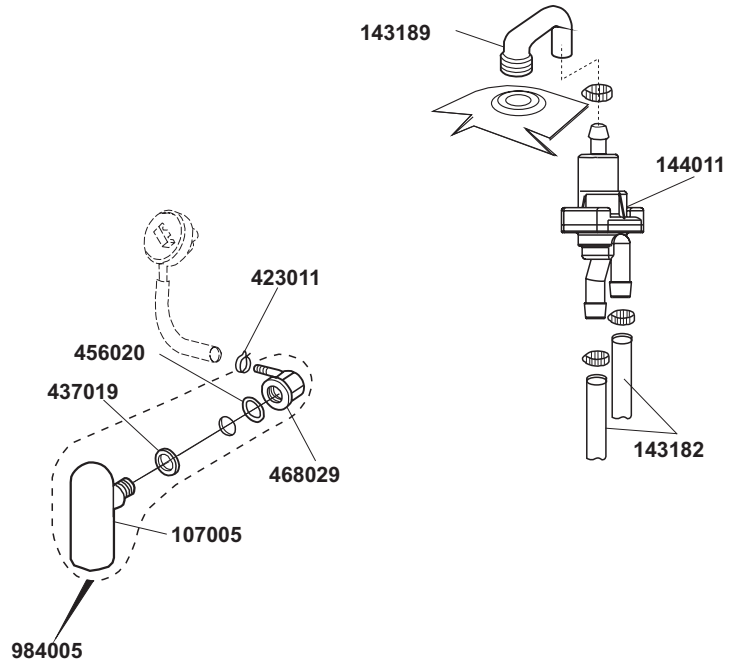
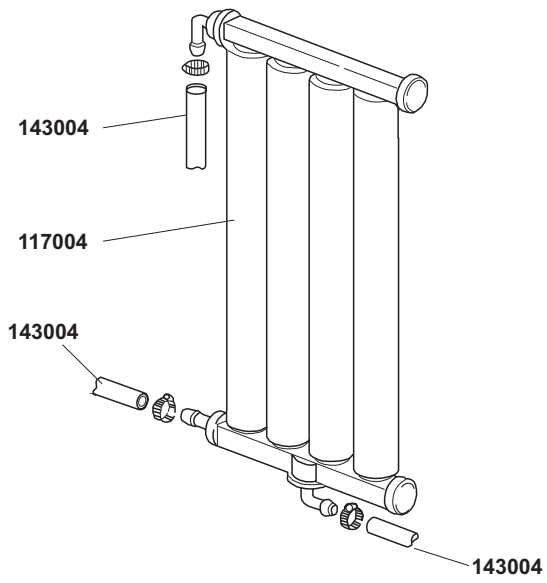

*Optional

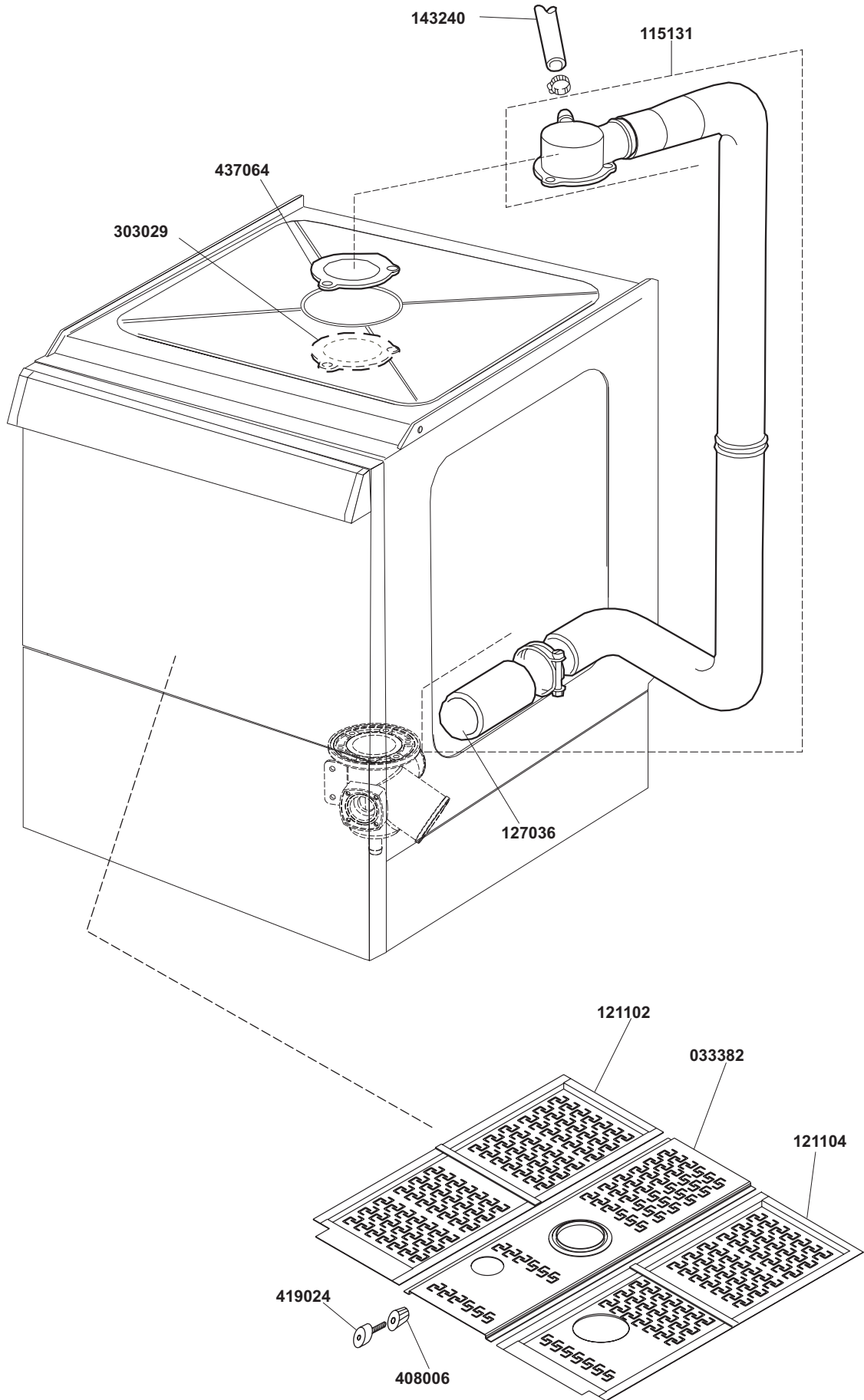

6

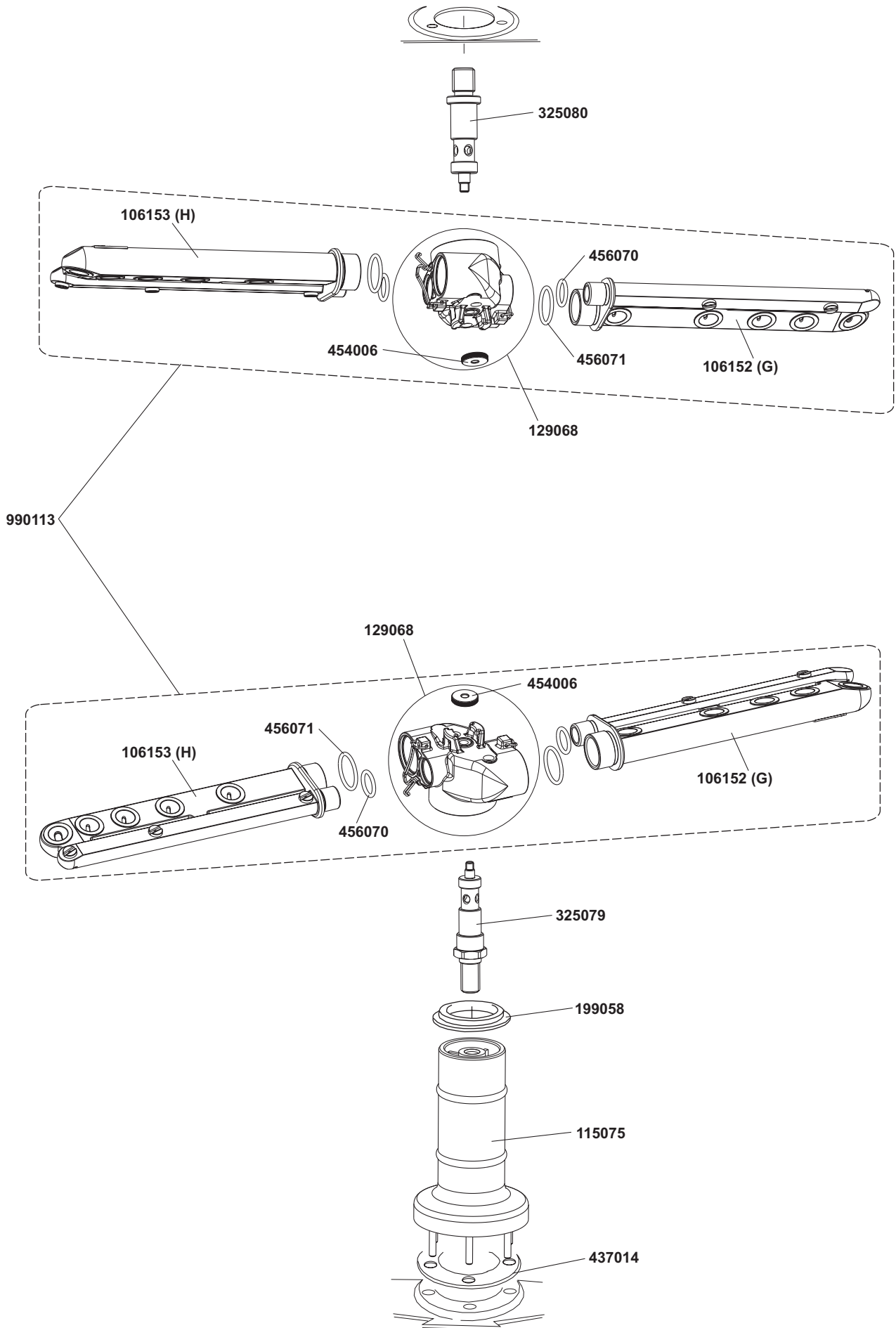

B. 237

130109 (230V- 50Hz)
130119 (230V- 60Hz)

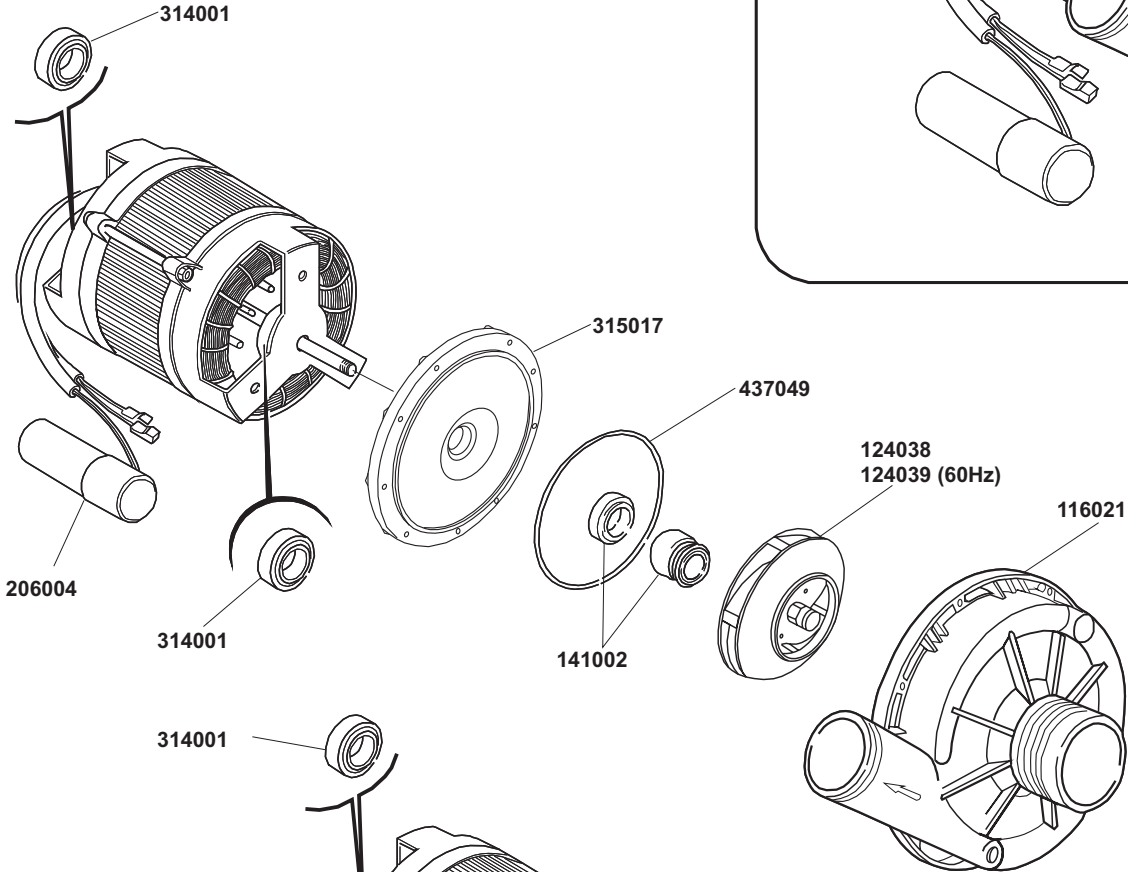
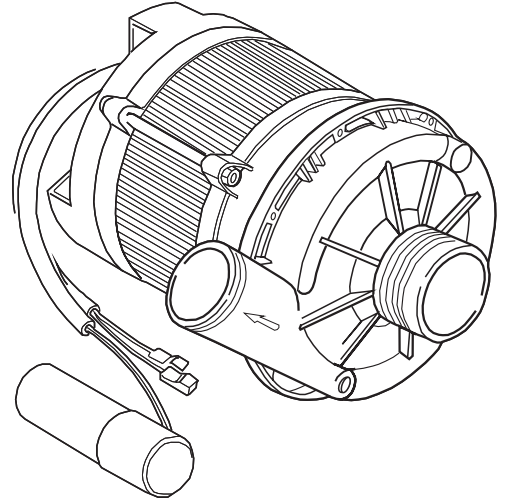

T. 173

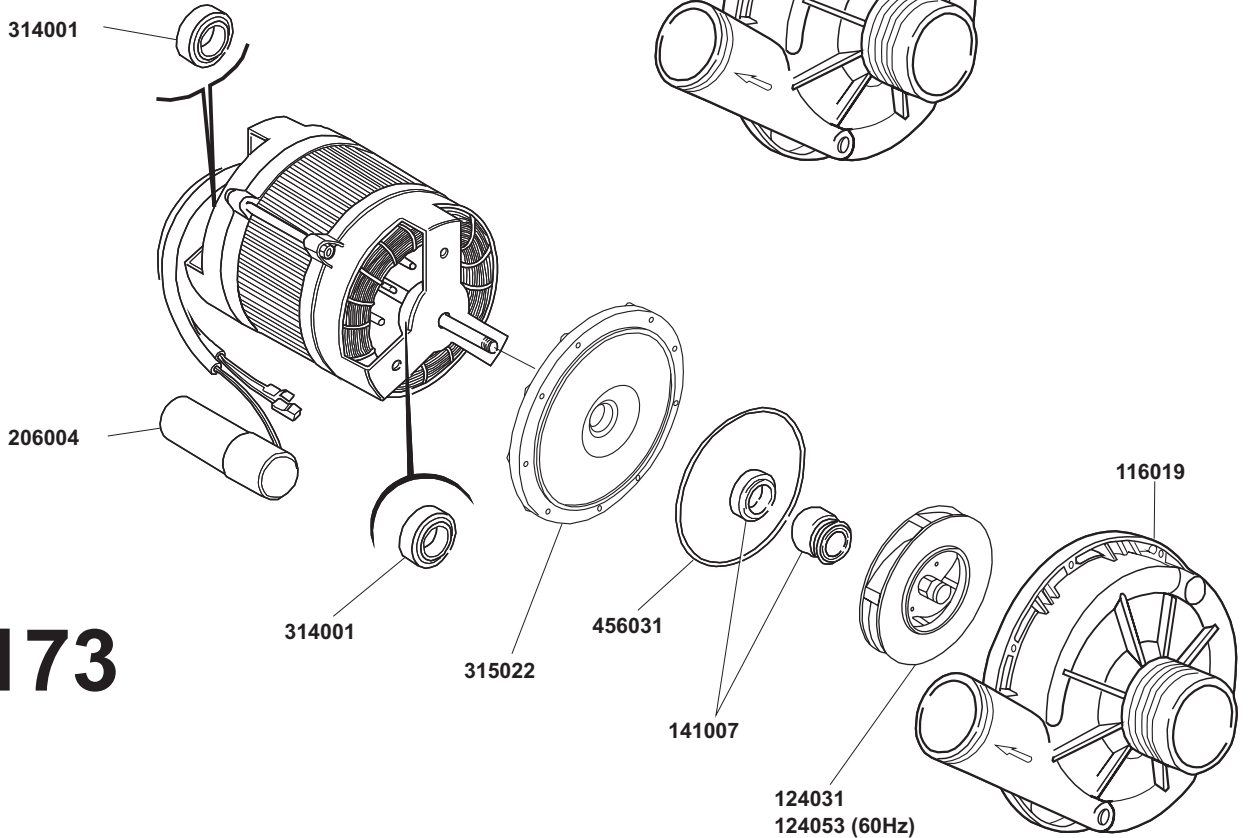

130126 (230V- 50Hz)
130133 (230V- 60Hz)

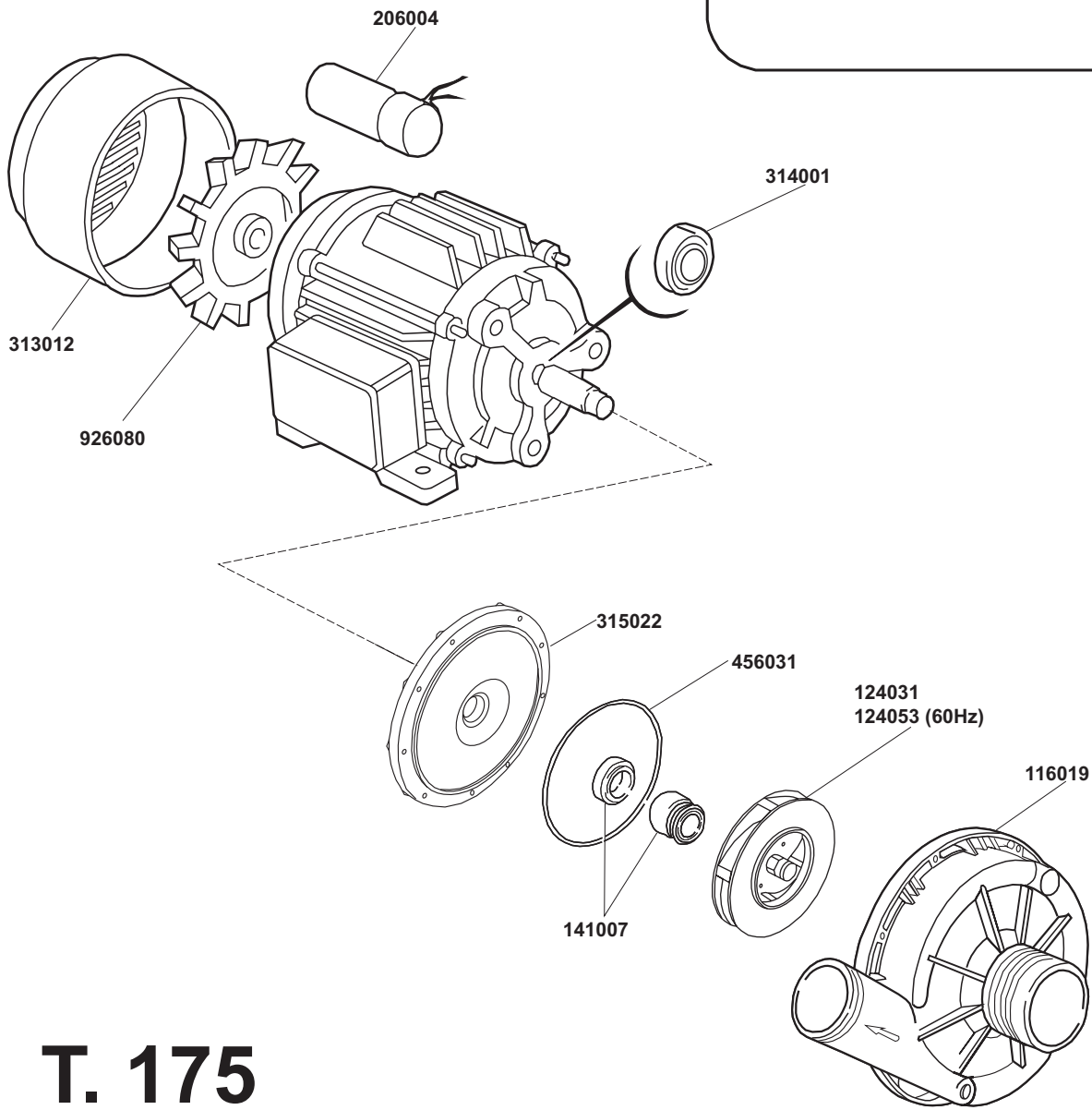
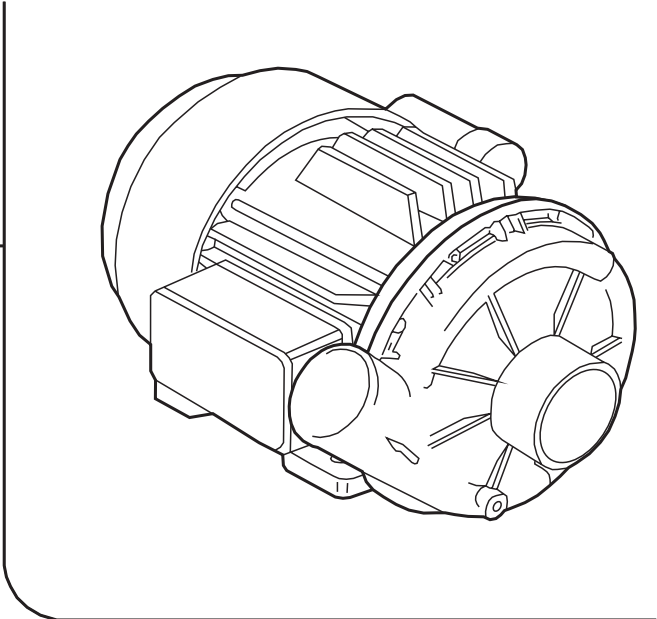

T. 175